



# MIRRORS

---

2026 Collection

KLAUS

HOFER

TATAY

jokey



KLAUS

20 February 2026

NEW!

# KLAUS

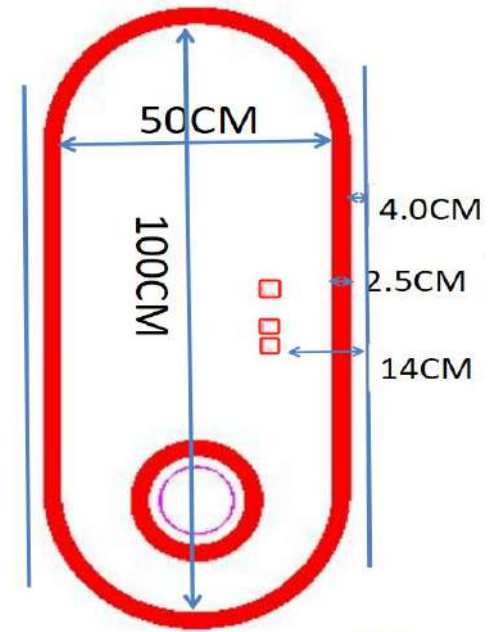

| Description                     | Referent            | Size         | Bar code      |
|---------------------------------|---------------------|--------------|---------------|
| <b>Bilbao Oval</b>              | NYT-LE-100X50cmx5mm | 100x50cmx5mm | 5291840025413 |
| Lumens 2000 Day light - IP44    |                     |              |               |
| Anti-fog                        |                     |              |               |
| Back and front light            |                     |              |               |
| Magnifying mirror               |                     |              |               |
| Instalation Vertical&Horizontal |                     |              |               |

NEW!

KLAUS



| Description                     | Referent          | Size         | Bar code      |
|---------------------------------|-------------------|--------------|---------------|
| <b>Bilbao Oval</b>              | NYT-NO-MAGNI/oval | 100x50cmx5mm | 5291840026113 |
| Lumens 1500 Day light - IP44    |                   |              |               |
| Anti-fog                        |                   |              |               |
| Back and front light            |                   |              |               |
| Instalation Vertical&Horizontal |                   |              |               |

NEW!

# KLAUS

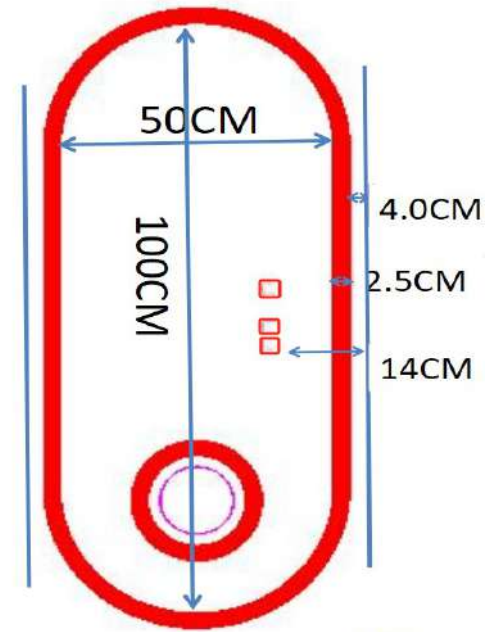

| Description  | Referent                                 | Size         | Bar code      |
|--|--|--------------|---------------|
| <b>San Sebastien</b><br>Lumens 2000 Day light - IP44<br>Anti-fog<br>Back and front light<br>Magnifying mirror<br>Instalation Vertical&Horizontal | San Sebastien<br>NYT-LED<br>120X80cmx5mm | 120X80cmx5mm | 5291840026342 |

NEW!

# KLAUS

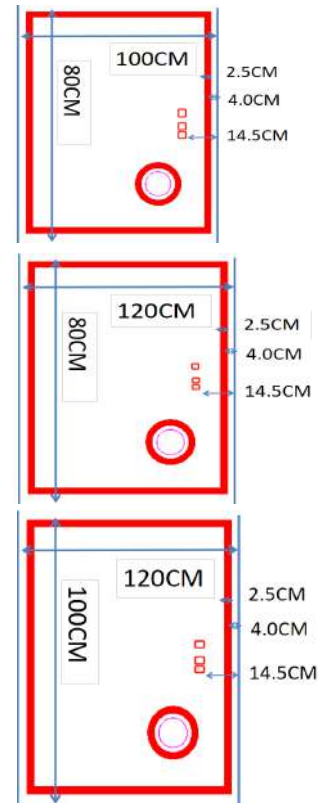

| Description  | Referent Nr.             | Size          | Bar code      |
|--|--------------------------|---------------|---------------|
| <b>Alexa mirror</b><br>Lumens 1500 Day light - IP44<br>Anti-fog<br>Back and front light<br>With magnifying mirror<br>Instalation Vertical or Horizontal  | NYT-LE-<br>100x80cmx5mm  | 100x80cmx5mm  | 5291840025352 |
| <b>Berlin mirror</b><br>Lumens 1500 Day light - IP44<br>Anti-fog<br>Back and front light<br>With magnifying mirror<br>Instalation Vertical or Horizontal | NYT-LE-<br>100x120cmx5mm | 120x100cmx5mm | 5291840025369 |
| <b>Oslo mirror</b><br>Lumens 1500 Day light - IP44<br>Anti-fog with back and front light<br>With magnifying mirror<br>Instalation Vertical or Horizontal | NYT-LE-<br>100x70cmx5mm  | 100x70cmx5mm  | 5291840025390 |

NEW!

KLAUS



| Description  | Referent Nr.       | Size          | Bar code      |
|--|--------------------|---------------|---------------|
| <b>Alexa mirror</b><br>Lumens 1500 Day light - IP44<br>Anti-fog<br>Back and front light<br>Instalation Vertical or Horizontal  | NYT-NO-MAGNI-10/8  | 100x80cmx5mm  | 5291840026120 |
| <b>Porto mirror</b><br>Lumens 1500 Day light - IP44<br>Anti-fog<br>Back and front light<br>Instalation Vertical or Horizontal  | NYT-NO-MAGNI-12/8  | 120x80cmx5mm  | 5291840026137 |
| <b>Berlin mirror</b><br>Lumens 1500 Day light - IP44<br>Anti-fog<br>Back and front light<br>Instalation Vertical or Horizontal | NYT-NO-MAGNI-12/10 | 120x100cmx5mm | 5291840026144 |
| <b>Oslo mirror</b><br>Lumens 1500 Day light - IP44<br>Anti-fog with back and front light<br>Instalation Vertical or Horizontal | NYT-NO-MAGNI-10/70 | 100x70cmx5mm  | 5291840026151 |

NEW!

KLAUS



**With magnifying  
mirror**

**ON THE RIGHT SIDE  
WHEN VERTICAL –  
WHEN HORIZONTAL  
- ON THE LEFT**

| Description   | Referent Nr.              | Size                        | Bar code      |
|---|---------------------------|-----------------------------|---------------|
| <b>Helsinki</b><br>Aluminium chrome matt frame 5.7mm<br>curve<br>Lumens 1500 Day light - IP44<br>Anti-fog<br>Front and back light<br>Magnifying mirror<br>Instalation Vertical & Horizontal | NYT-FRCH-<br>80X60cmx5mm  | 80x60cmx5mm<br>Frame 5.7mm  | 5291840025444 |
| <b>Granada</b><br>Aluminium chrome matt frame 5.7mm<br>curve<br>Lumens 1500 Day light - IP44<br>Anti-fog<br>Front and back light<br>Magnifying mirror<br>Instalation Vertical & Horizontal  | NYT-FRCH-<br>100X80cmx5mm | 100X80cmx5mm<br>Frame 5.7mm | 5291840025451 |
| <b>Leondia</b><br>Aluminium chrome matt frame 5.7mm<br>curve<br>Lumens 1500 Day light - IP44<br>Anti-fog<br>Front and back light<br>Magnifying mirror<br>Instalation Vertical & Horizontal  | NYT-FRCH-<br>120X80cmx5mm | 120x80cmx5mm<br>Frame 5.7mm | 5291840025468 |



| Description  | Referent Nr.         | Size                        | Bar code      |
|--|----------------------|-----------------------------|---------------|
| <b>Helsinki</b><br>Aluminium black matt frame 5.7mm<br>Lumens 1500 Day light - IP44<br>Anti-fog<br>Front and back light<br>Instalation Vertical & Horizontal | NYT-B/NO/<br>MAG/80  | 80x60cmx5mm<br>Frame 5.7mm  | 5291840026175 |
| <b>Granada</b><br>Aluminium black matt frame 5.7mm<br>Lumens 1500 Day light - IP44<br>Anti-fog<br>Front and back light<br>Instalation Vertical & Horizontal  | NYT-B/NO/<br>MAG/100 | 100X80cmx5mm<br>Frame 5.7mm | 5291840026182 |
| <b>Leondia</b><br>Aluminium black matt frame 5.7mm<br>Lumens 1500 Day light - IP44<br>Anti-fog<br>Front and back light<br>Instalation Vertical & Horizontal  | NYT-B/NO/<br>MAG/120 | 120x80cmx5mm<br>Frame 5.7mm | 5291840026199 |

NEW!

KLAUS

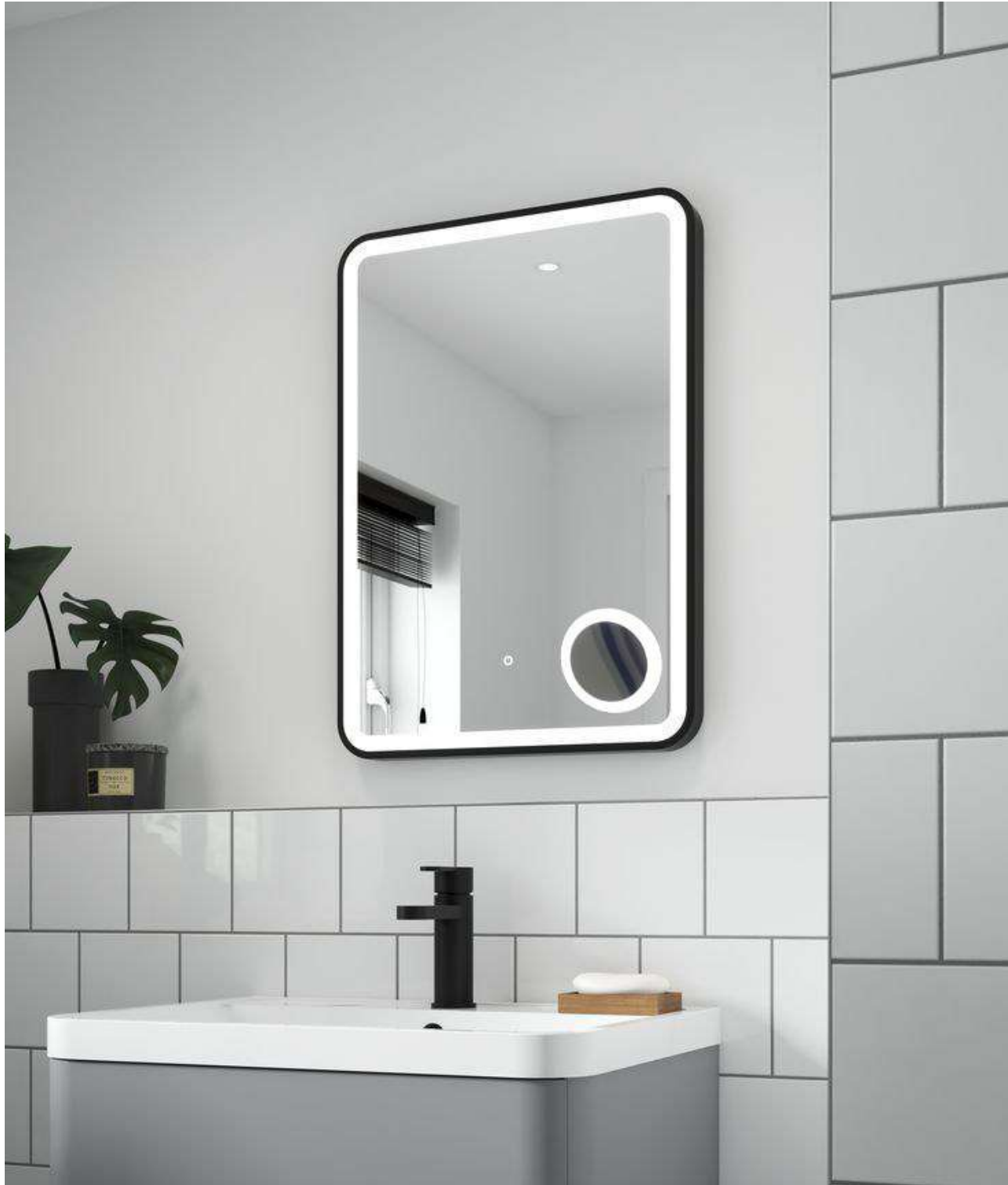

| Description   | Ref. Nr.                   | Size                        | Bar code      |
|---|----------------------------|-----------------------------|---------------|
| <b>Faro</b><br>Black Matt Aluminum Curve frame 5.7mm<br>Lumens 1500 - Day light - Anti-fog<br>curve | NYT-FRB-<br>80x60cmx5.7mm  | 80x60cmx5.7mm               | 5291840025475 |
|   | NYT-FRB-<br>100x80cmx5.7mm | 100x80cmx5.7mm              | 5291840025482 |
| Front and back light - IP44<br>Magnifying mirror  | NYT-FRB-<br>120x80x5mm     | 120x80cmx5mm<br>Frame 5.7mm | 5291840025499 |
| Instalation Vertical & Horizontal   |                            |                             |               |



| Description   | Ref. Nr.       | Size        | Bar code      |
|---|----------------|-------------|---------------|
| <b>VIENNA Led mirror IP44</b><br>Lumens 1500 - Day light<br>Curve<br>Front & background wall illumination<br>Instalation : Horizontal or Vertical<br>With magnifying mirror | NYT-LED-6-IP44 | 60x80cmx5mm | 5291840025246 |



| Description  | Ref. Nr.       | Size        | Bar code      |
|--|----------------|-------------|---------------|
| <b>VIENNA Led mirror IP44</b><br>Lumens 1500 - Day light<br>Curve<br>Front & background wall illumination<br>Instalation : Horizontal or Vertical<br>W/out Magnifying mirror | NYT-LED-6-IP44 | 60x80cmx5mm | 5291840027004 |



| Description  | Ref. Nr. | Size        | Bar code      |
|--|----------|-------------|---------------|
| <b>MALMO Led mirror</b><br>Lumens 1500 - Day light | NYT-FOG  | 60x80cmx5mm | 5291840024904 |
| Front & background wall illumination               |          |             |               |
| Magnifying mirror                                  |          |             |               |
| Anti-fog   |          |             |               |
| Instalation Horizontal or Vertical                 |          |             |               |
| IP44   |          |             |               |

NEW!

KLAUS



| Description   | Ref. Nr.              | Size       | Bar code      |
|---|-----------------------|------------|---------------|
| <b>Bamberg</b><br>Led round mirror 80cmx5mm<br>IP44 / Lumens 1500 / Day light / Anti-fog /<br>Illumination in front & back side /<br>Magnifying mirror /<br>Instalation Horizontal or Vertical<br><b>With magnifying mirror</b> | NYT-LE-<br>80cm Round | 80cm Round | 5291840025383 |

NEW!

KLAUS



| Description | Ref. Nr. | Size | Bar code |
|-------------|----------|------|----------|
|-------------|----------|------|----------|

**EARTH**  
Led ROUND mirror 80cmx5mm  
BLACK FRAME MATT 5.7mm  
IP44 / Lumens 1500 / Day light / Anti-fog /  
Illumination in front & back side /  
Instalation Horizontal or Vertical

NYT-B/NO MAG/80 80cm Round 5291840026205

# LUMENS TO WATTS

## CONVERSION CHEAT SHEET

Brightness  
in Lumens

220+



400+



700+



900+



1300+



STANDARD

25W

40W

60W

75W

100W



HALOGEN

18W

28W

42W

53W

70W



CFL

6W

9W

12W

15W

20W



LED

4W

6W

10W

13W

18W



THECANCONVERTER.COM



NEW!



# Multistar



## Equipment

Illuminated mirror with integrated Euro socket, 1x USB + 1x USB-C, ON/OFF switch, high suspension

## Lighting

LED-lighting, consumption: 17 watts, brightness: 3.086 lumens, light color: 4.000 Kelvin neutral white, protection class: IP 20

## Dimensions (W/H/D)

50,0 / 70,0 / 3,5 cm



Article-no.:  
EAN-No.:

49060480  
4002177576568



| Photo  | Description  | Ref. Nr.       | Bar code      |
|--|--|----------------|---------------|
|   | <p><b>ENTRO Cabinet mirror - MDF/WOOD</b></p> <p>Dimensions: W50cm / H74cm / D14cm</p> <p>Color: White corpus, aluminum colored<br/>Thick rim</p> <p>Illumination: Recommended for 1 x E27 LED lamps (not included)</p> <p>IP: 20</p> <p>Specifications: Large mirrored crystal glass door safety socket and switch within easy reach at bottom right</p>                                  | 111911010-0140 | 4013251859415 |
|   | <p><b>DORO Cabinet mirror - MDF/WOOD</b></p> <p>Dimensions: W67.5cm / H60cm / D22cm</p> <p>Color: White, aluminum</p> <p>Illumination: 2 LED spots, 240 Lumens  </p> <p>Light: color Neutral-white</p> <p>IP: 20</p> <p>Specifications: 3 mirrored crystal glass doors, adjustable glass shelves, safety socket &amp; switch</p>   | 111913510-0110 | 4013251001906 |
|  | <p><b>CENTO 50 Cabinet mirror - MDF/WOOD</b></p> <p>Dimensions: W50cm / H65cm / D14cm</p> <p>Color: White corpus, aluminum colored thick rim<br/>Illumination: Lumens 540 Led</p> <p>Light: colour Neutral-white</p> <p>IP: 20</p> <p>Specifications: 1 mirrored crystal glass doors, adjustable glass shelves, safety socket &amp; switch within easy reach at bottom right</p>           | 114311010-0140 | 4013251864280 |
|  | <p><b>CENTO 60 Cabinet mirror MDF/WOOD</b></p> <p>Dimensions: W60cm / H 65cm / D 14cm</p> <p>Color: White corpus, aluminum colored thick rim</p> <p>Illumination: LED light strip, 540 Lumens</p> <p>Light: color Neutral-white - IP: 20</p> <p>Specifications: 2 mirrored crystal glass doors, adjustable glass shelves, safety socket &amp; switch within easy reach at bottom right</p> | 114312010-0140 | 4013251864259 |

| Photo  | Description  | Ref. Nr.       | Bar code      |
|--|--|----------------|---------------|
|    | <p><b>Kandi LED Mirror cabinet - MDF / Wood</b><br/>                     Chrome finish - W60cm x H 70cm x D9cm</p> <p>Lighting: LED top light, 540 lumens,<br/>                     light color neutral white</p> <p>2 mirror doors made of crystal glass<br/>                     adjustable glass inserts<br/>                     Socket &amp; on/off switch / Weight: 9.4 kg</p> <p>IP: 20</p>       | 111912212-D    | 4013251007700 |
|   | <p><b>Kandi Led mirror cabinet - MDF / Wood</b><br/>                     Black matt finish - W60cm x H 70cm x D9cm</p> <p>Lighting: LED top light, 540 lumens,<br/>                     light color: neutral white</p> <p>2 mirror doors made of crystal glass<br/>                     adjustable glass inserts /<br/>                     Socket &amp; on/off switch /Weight: 9.4 kg</p> <p>IP: 20</p> | 111912212-0700 | 4013251010656 |
|  | <p><b>“E-LIGHT THREE” Led mirror model</b><br/>                     W50cmxH70cm</p> <p>Lumen 132 Light color</p> <p>Energy-efficiency class A++</p> <p>IP: 20</p>  | 48000080       | 4002177558380 |
|  | <p><b>SIRIUS II - LED light mirror</b><br/>                     60x80cm High</p> <p>Lumen 903 Light color<br/>                     Including touch switch</p> <p>Energy-efficiency class A++</p> <p>IP: 20</p>   | 48002112       | 4002177568693 |
|  | <p><b>SIRIUS III - LED light mirror</b><br/>                     90x60cm High</p> <p>Lumen 903 Light color<br/>                     Including touch switch</p> <p>Energy-efficiency class A++</p> <p>IP: 20</p>  | 48002113       | 4002177568709 |

| Photo  | Description   | Ref. Nr. | Bar code      |
|--|---|----------|---------------|
|    | <p><b>“ROOMLIGHT I” Curve LED mirror</b></p> <p>Dimensions: W60cm x H80cm</p> <p>Lumen: 805 Light color<br/>Class A+</p> <p>Equipment: Sensor switch</p> <p>Weight: 5.46 kg</p> <p>IP: 20</p>   | 48008010 | 4002177568532 |
|   | <p><b>“ROOMLIGHT II” Curve LED mirror</b></p> <p>Dimensions : W50cmxH70cm</p> <p>Lumen: 756 Light color<br/>Class A++</p> <p>Equipment: Sensor switch</p> <p>Weight: 5.46 kg</p> <p>IP: 20</p>  | 48008020 | 4002177569096 |
|  | <p><b>“ROOMLIGHT III” Curve LED mirror</b></p> <p>Dimensions: W80cm x H60 cm</p> <p>Lumen 485 Light color / Class A ++</p> <p>Equipment: Sensor switch</p> <p>Weight: 5.43 kg</p> <p>IP: 20</p>   | 48008030 | 4002177574304 |
|  | <p><b>"SALERNO" Curve LED mirror</b></p> <p>Dimensions: W50 cm x H 70 cm<br/>Lumen 1080 light Neutral with switch</p> <p>The mirrored high-quality clear glass design with rounded corners and the elegantly framed all-round lighting module gives you a clever styling partner and an additional light source in the bathroom, entrance area or at the make-up area in the bedroom. on/off sensor switch is included.</p> <p>IP: 20</p> | 49060100 | 4002177575721 |



Description

Ref. Nr.

Bar code

**OXFORD** Led

49060080

4002177575707

Size 60x80cmx5mm

Incl. touch switch and illuminated make-up mirror, 3x magnifying

Lumens 870 neutral-white

IP: 44



Description

Ref. Nr.

Bar code

**LED Lines III**

9951

4002177566774

Size 40x6,5x11 cm

Light color neutral-white

Wattage 6 | Lumens 400

2 Years warranty

Energy rating "A"

IP: 44

# LUMENS TO WATTS

## CONVERSION CHEAT SHEET

Brightness  
in Lumens

220+



400+



700+



900+



1300+



STANDARD

25W

40W

60W

75W

100W



HALOGEN

18W

28W

42W

53W

70W



CFL

6W

9W

12W

15W

20W



LED

4W

6W





10W

13W

18W



THECANCONVERTER.COM

| Photo  | Description   | Ref. Nr. | Bar code      |
|--|---|----------|---------------|
|    | <b>Sevilla 1 Led</b><br>Round mirror 55cm<br>Lumen 700<br>Light neutral white<br>IP: 20   | 49060050 | 4002177575677 |
|    | <b>Sevilla 2 Led</b><br>Round mirror 65cm<br>Lumen 830<br>Light neutral white<br>IP: 20   | 49060060 | 4002177575684 |
|   | <b>FRAMELIGHT I LED mirror</b><br>60x80cmH.<br>Lumen 903<br>Including touch switch<br>Energy-efficiency class A++<br>Light neutral white<br>IP: 20  | 48007010 | 4002177568525 |
|  | <b>FRAMELIGHT II Led Mirror</b><br>50x70cmH.<br>Lumen 735 / Light neutral white<br>Including touch switch<br>Energy-efficiency class A++<br>IP: 20  | 48007020 | 4002177569089 |
|  | <b>FRAMELIGHT III Led Mirror</b><br>80x60cmH.<br>Lumen 903 / Light neutral white<br>Including touch switch<br>Energy-efficiency class A++<br>IP: 20 | 48007030 | 4002177574311 |

«Καθρέφτης LED με βαθμολογία IP44»

Συνοψίζοντας, όταν αγοράζετε έναν φωτιζόμενο καθρέφτη, αναζητήστε να έχει την βαθμολογία IP44 στην περιγραφή του προϊόντος. Αυτή η βαθμολογία υποδεικνύει ότι ο καθρέφτης είναι κατάλληλος για χρήση σε χώρους όπου υπάρχει νερό.

Όπως μπάνια / ντους / υγρά δωμάτια, παρέχοντας παράλληλα προστασία από υγρασία και πιτσιλιές νερού.

“Mirror LED with IP44 rating”

In summary, when shopping for an illuminated mirror, look for IP44 rating in the product description.

This rating indicates that the mirror is suitable for use in areas like bathroom / shower.

Such as bathrooms and wet rooms, whilst providing protection against moisture and splashes of water.

Για την τοποθέτηση καθρέφτη με “IP44” ακολουθήστε τις αποστάσεις του σκιαγραφήματος, οι οποίες και καθορίζονται στα 60cm.

Στην Γερμανία παράδειγμα είναι αποδεκτό και το IP20 αλλά με απόσταση του ενός μέτρου από το μπάνιο/ντους



## SCHUTZBEREICH / SAFETY AREA

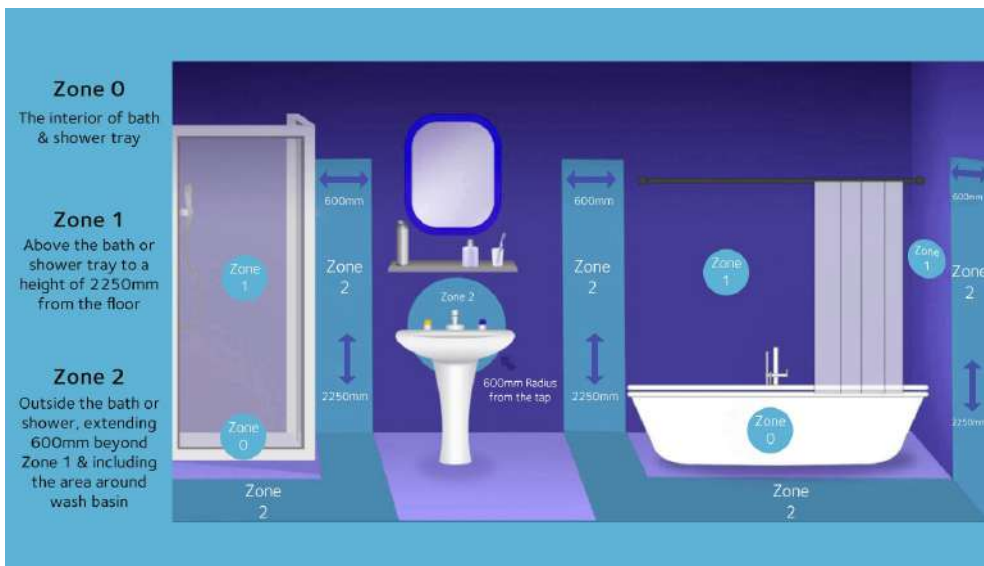
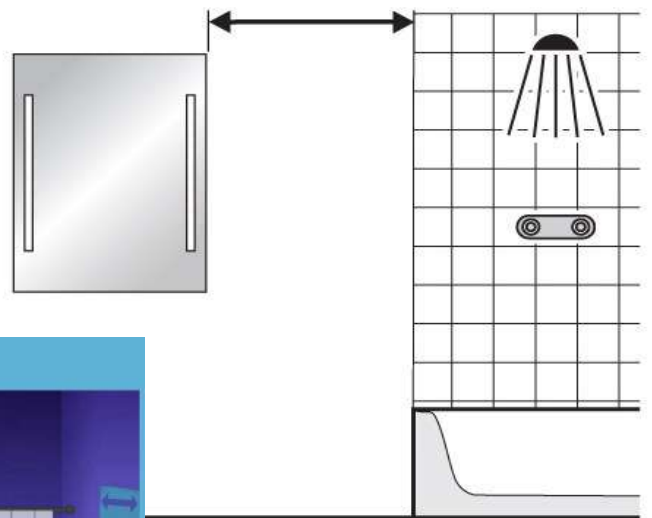

|     |                    |     |                      |
|-----|--------------------|-----|----------------------|
| F   | Zone de protection | RO  | Domeniu de protecție |
| TR  | Korunma bölümü     | SLO | Zaščitno območje     |
| RUS | Защитная зона      | I   | Zone de protezione   |
| NL  | Veiligheidsruimte  | HR  | Zaštićeno područje   |
| PL  | Strefa ochonna     | E   | Zona de protecció    |
| CZ  | Ochranné pásmo     | P   | Zona de protecção    |
| SK  | Ochranné pásmo     | DK  | Sikkerhedsafstand    |
| H   | Védett terület     | FIN | Turva-alue           |
| BG  | Защитен участък    | GR  | Περιοχή προστασίας   |

Minimum: 60 cm









| Photo  | Description  | Ref. Nr. | Bar code      |
|--|--|----------|---------------|
|    | <p><b>FRAME mirror WOOD VERDE 46X111</b></p> <p>Dimensions: width 46 cm x height 111 cm</p> <p>Mirror type: Living room mirror</p> <p>Suspension: Both</p> <p>Equipment: Wooden frame hanger available</p> | 99980999 | 4002177090262 |
|   | <p><b>FRAME mirror WOOD VERDE 46X111</b></p> <p>Dimensions: width 46 cm x height 111 cm</p> <p>Mirror type: Living room mirror</p> <p>Suspension: Both</p> <p>Equipment: Wooden frame hanger available</p> | 99981999 | 4002177090293 |
|  | <p><b>FRAME mirror WOOD VERDE 55X75</b></p> <p>Dimensions: width 55 cm x height 75 cm</p> <p>Mirror type: Living room mirror</p> <p>Suspension: Both</p> <p>Equipment: Wooden frame hanger available</p>   | 99984999 | 4002177092846 |
|  | <p><b>FRAME mirror WOOD VERDE 55X75</b></p> <p>Dimensions: width 55 cm x height 75 cm</p> <p>Mirror type: Living room mirror</p> <p>Suspension: Both</p> <p>Equipment: Wooden frame hanger available</p>   | 99985999 | 4002177092877 |



| Photo | Description   | Ref. Nr. | Bar code      |
|-------|---|----------|---------------|
|       | <p><b>Mirror model "TOUCH"</b></p> <p>Width 39cmx111cm High</p> <p>included adhesive tape</p> <p>Door or wall mirror</p>  | 10080104 | 4002177000063 |
|       | <p><b>Mirror model "TOUCH"</b></p> <p>Width 39cmx140cm High</p> <p>included adhesive tape</p> <p>Door or wall mirror</p>  | 10040114 | 4002177045347 |
|       | <p><b>Kritall-Spiegel</b></p> <p>Width 40cmx170cm High</p> <p>Included on the mirror the clamping support for vertical instalation only</p> <p>For horizontal instalation, ask for mirror extra clamping support set 4pcs</p> | 10200040 | 4002177568839 |
|       | <p><b>Mirror clamping support set of 4pcs</b></p> <p>Capacity 5Kilos</p>  | 19060000 | 4002177009905 |

| photo  | description   | Ref.Nr.  | Bar code                                   |
|--|---|----------|--|
|    | <p><b>MIRROR GENNIL 55x80cmx5mm</b></p> <p>Dimensions: W.55cm x H.80cmx5mm<br/>Can be placed vertical and horizontal</p> <p>Equipment: bijoute 13 mm</p> <p>Adhesive included</p> <p><b>ΤΟΠΟΘΕΤΕΙΤΑΙ ΚΑΙ ΟΡΙΖΟΝΤΙΑ ΕΑΝ ΑΓΟΡΑΣΕΤΕ ΤΗΝ ΕΞΤΡΑ ΒΑΣΗ ΣΤΗΡΙΞΗΣ ΤΟΥ ΚΑΘΡΕΦΤΗ 8CMX10CM REF.19010081 €4.90</b></p>     | 20030185 | 4002177000766<br>(2 pieces in one package) |
|  | <p><b>MIRROR GENNIL 40X60cmx5mm</b></p> <p>Dimensions: W.40cm x H.60cmx5mm</p> <p>Can be placed vertical and horizontal<br/>13 mm adhesive sheets available</p> <p><b>ΤΟΠΟΘΕΤΕΙΤΑΙ ΚΑΙ ΟΡΙΖΟΝΤΙΑ ΕΑΝ ΑΓΟΡΑΣΕΤΕ ΤΗΝ ΕΞΤΡΑ ΒΑΣΗ ΣΤΗΡΙΞΗΣ ΤΟΥ ΚΑΘΡΕΦΤΗ 8CMX10CM REF.19010081 €4.90</b></p>                       | 20010164 | 4002177000742                              |
|  | <p><b>MIRROR CHECK KARO 55x70cmx5mm</b></p> <p>Dimensions: W.55cm x H.70cmx5mm</p> <p>Can be placed vertical and horizontal<br/>Equipment: bijoute 13 mm</p> <p>Adhesive included</p> <p><b>ΤΟΠΟΘΕΤΕΙΤΑΙ ΚΑΙ ΟΡΙΖΟΝΤΙΑ ΕΑΝ ΑΓΟΡΑΣΕΤΕ ΤΗΝ ΕΞΤΡΑ ΒΑΣΗ ΣΤΗΡΙΞΗΣ ΤΟΥ ΚΑΘΡΕΦΤΗ 8CMX10CM REF.19010081 €4.90</b></p> | 65450157 | 4002177307902                              |
|  | <p><b>MIRROR CHECK KARO 70x90cmx5mm</b></p> <p>Dimensions: W.70cm x H.90cmx5mm<br/>Can be placed vertical and horizontal<br/>Equipment: bijoute 13 mm<br/>Adhesive included</p> <p><b>ΤΟΠΟΘΕΤΕΙΤΑΙ ΚΑΙ ΟΡΙΖΟΝΤΙΑ ΕΑΝ ΑΓΟΡΑΣΕΤΕ ΤΗΝ ΕΞΤΡΑ ΒΑΣΗ ΣΤΗΡΙΞΗΣ ΤΟΥ ΚΑΘΡΕΦΤΗ 8CMX10CM REF.19010081 €4.90</b></p>       | 65450179 | 4002177080454                              |

| Photo   | Description   | Ref.Nr. | Bar code      |
|---|---|---------|---------------|
|     | <p><b>Lymo Cabinet white</b></p> <p>Material: Plastic</p> <p>Dimensions: 59/49.5/14.5cm</p> <p>Features: 3 crystal glass mirror doors with 3-D-mirror effect, Medium mirror with storage space, Fixed cabinet inserts</p> <p>Push socket</p>    | 84132   | 4013251862101 |
|    | <p><b>Junior Cabinet White (1 door)</b></p> <p>Material: Plastic</p> <p>Dimensions: 31.5/40/14 cm</p> <p>Features: 1 Crystal glass mirror door</p> <p>Fixed cabinet inserts</p>   | 84110   | 4013251807805 |
|  | <p><b>Medi White (one-door)</b></p> <p>Material: Plastic</p> <p>Dimensions: 31.5/42/15 cm</p> <p>Features: Adjustable cabinet inserts, Door storage bowls, Green cross sticker, Lock</p> <p>Drawer console: With 1 drawer and scratch-proof</p> | 83310   | 4013251807409 |

| photo  | description  | Ref.Nr.  | Bar code      |
|--|--|----------|---------------|
|   | <p><b>Make-up mirror SALVIA 16,5X16,5 cm</b><br/>           Magnifying mirror 300%<br/> <b>With light &amp; switch on /off</b><br/>           Dimensions: width 16.5 cm x height 16.5 cm<br/>           Mirror type: cosmetic mirror<br/>           Equipment: frame made of KS, pressure switch</p> | 19070020 | 4002177568594 |
|    | <p><b>Make-up mirror KANIA 17,3X17,3 cm</b><br/>           Magnifying mirror 300%<br/>           Dimensions: width 17.3 cm x height 17.3 cm<br/>           Mirror type: cosmetic mirror<br/>           Equipment: frame from KS</p>  | 19070010 | 4002177568587 |
|  | <p><b>COSMETIC mirror VINCA 16X16 cm</b><br/>           Magnifying mirror 300%<br/>           Dimensions: width 16 cm x height 16 cm<br/>           Mirror type: cosmetic mirror<br/>           Equipment: frame from KS</p>   | 19070030 | 4002177568600 |
|  | <p><b>MAKE-UP mirror VIVIENNE 18X38 cm</b><br/>           Magnifying mirror 17 cm X 2 zoom<br/>           Dimensions: width 38 cm x height 18cm<br/>           Mirror type: cosmetic mirror<br/>           Equipment: frame made of metal</p>  | 19070000 | 4002177019430 |

| Photo  | Description  | Ref. Nr.             | Bar code                       |                 |
|--|--|----------------------|--------------------------------|-----------------|
|    | <b>Kristall Form mirror</b><br>Size: 40X60 Width of the frame: 3 cm<br>Material: extrusion plastic (polystyrol) with foil coated.<br>Can be placed vertical and horizontal | 69000030<br>69000031 | 4002177564015<br>4002177564022 | Green<br>Pink   |
|  | <b>Kristall Form mirror</b><br>Size: 40x100x15mm frame<br>Material: extrusion plastic (polystyrol) with foil coated.<br>Can be placed vertical and horizontal              | 69000022<br>69000024 | 4002177563933<br>4002177563957 | Silver<br>Green |
|  | <b>MOUNTING SYSTEM MIRROR</b><br><b>HANGING PANEL 8X10 cm</b><br>For mirrors up to 2.4 kilos p.p.  | 19010081             | 4002177000315                  | 4.90p.p         |
|  | <b>CLEAR GLASS TRAYS</b><br>Size 50 x 14 cm  | 19450050             | 4002177075832                  | 8.40€           |
|  | <b>GLASS SHELF SUPPORT</b><br>Chromium-plated metal, 1 pair  | 19450000             | 4002177075825                  | 10.00€          |



## declaration of conformity



|                                     |   |  |
|-------------------------------------|---|--|
| <b>Manufacturers name</b>           | Jokey Plastik Sohland GmbH  |  |
| <b>Complete adress</b>              | Industriestr. 4<br>02689 Sohland / Spree<br>Germany                                   |  |
| <b>Products</b>                     | <b>bathroom products, illuminated mirrors</b>   |  |
| <b>Type designation / providers</b> | <b>All types</b>  |  |
|                                     | <b>The designed products are comply with the requirements of following documents:</b> |  |
| <b>1 Safety</b>                     | <b>2014/35/EU</b>   | Low voltage directive  |
| <b>1.1</b>                          | <b>EN 60598-1:2015</b>  | Luminaires- Part 1: General requirements and tests (before 2008 + A11)   |
| <b>1.2</b>                          | <b>EN 60598-2-1:1989</b>  | Luminaires; part 2: particular requirements; section one: fixed general purpose luminaires   |
| <b>1.3 PAK/PAH</b>                  | <b>2013/1272/EU</b>   | Registration, Evaluation, Authorisation and Restriction of Chemicals (REACH) as regards polycyclic aromatic hydrocarbons (before ZEK 01.2-08/12.08, current 01.4-08)   |
|                                     | <b>AIPS GS 2014:01 PAK</b>  |  |
| <b>1.4 EMF</b>                      | <b>EN 62493:2010</b>  | Assessment of lighting equipment related to human exposure to electromagnetic fields   |
| <b>1.5 Photobiology</b>             | <b>EN 62471:2008</b>  | Photobiological safety of lamps and lamp systems   |
| <b>2 EMC</b>                        | <b>2014/30/EU</b>   | Directive relating to electromagnetic compatibility (before 2004/108/EC)   |
| <b>2.1</b>                          | <b>EN 55015 :2015</b>   | Limits and methods of measurement of radio disturbance characteristics of electrical lighting and similar equipment (before 2006 + A1:2007 + A2:2009)  |
| <b>2.2</b>                          | <b>EN 61000-3-2:2015</b>  | Electromagnetic compatibility (EMC) - Part 3-2: Limits - Limits for harmonic current emissions (before 2006 + A1:2009 + A2:2009)   |
| <b>2.3</b>                          | <b>EN 61000-3-3:2014</b>  | Electromagnetic compatibility (EMC) - Part 3-3: Limits - Limitation of voltage changes, voltage fluctuations and flicker in public low-voltage supply systems, for equipment with rated current <=16 A per phase and not subject to conditional connection (before 2008) |
| <b>2.4</b>                          | <b>EN 61547:2010, Ber. 1:2010</b>   | Equipment for general lighting purposes- EMC immunity requirements (before 2009)   |





|                           |                              |  |
|---------------------------|------------------------------|--|
| <b>3 REACH</b>            | <b>2006/1907/EC</b>          | Registration, Evaluation, Authorisation and Restriction of Chemicals (REACH)   |
| <b>4 RoHS II</b>          | <b>2011/65/EG</b>            | Restriction of Hazardous Substances; includes 2015/863 (before 2002/95/EG)   |
| <b>5 WEEE</b>             | <b>2012/19/EU</b>            | Directive on waste electrical and electronic equipment (WEEE)  |
| <b>6 ÖKODESIGN</b>        | <b>2009/125/EC</b>           | eco-design requirements for energy related products  |
| <b>6.1</b>                | <b>244/2009/EC</b>           | non-directional household lamps  |
| <b>6.2</b>                | <b>1194/2012/EU</b>          | directional lamps, light emitting diode lamps and related equipment  |
| <b>6.3</b>                | <b>2010/30/EU</b>            | labelling and standard product information of the consumption of energy and other resources by energy-related products |
| <b>6.4</b>                | <b>2012/874/EU</b>           | Energy labelling of electrical lamps and luminaires  |
| <b>7 tests in factory</b> | <b>according to EN 60598</b> | 100%<br>1 visual inspection<br>2 insulation<br>3 earth contact<br>4 function   |

**Phone, Fax, E-Mail**

Tel. 035936 36-0, Fax 035936 36-2222, Email info@jokey.com

www.jokey-online.com

Don't hesitate to ask for more information.

Signed for and on behalf of:

Jokey Plastik Sohland GmbH

Sohland, 13.12.2019

(date and place)

Marcus Blumenschein, General Manager

(name and function)

(signature)

**Jokey Plastik Sohland GmbH**  
Industriestraße 4  
02689 Sohland a. d. Spree

**Μοντέλο προϊόντος** 48007010; 48007030; 48002112; 48008010;  
48008030

**Κατασκευαστής** Jokey Sohland GmbH  
Industriestr. 4  
02689 Sohland / Spree  
Germany

**Η παρούσα δήλωση συμμόρφωσης εκδίδεται με αποκλειστική ευθύνη του κατασκευαστή.**

**Στόχος της δήλωσης** Ντουλάπι καθρέφτη Προϊόντα μπάνιου

Ο στόχος της δήλωσης που περιγράφεται παραπάνω είναι σύμφωνος με τη σχετική ενωσιακή νομοθεσία εναρμόνισης:

|                        |  |  |
|------------------------|--|--|
| <b>2014/35/ΕΕ</b>      | ΟΔΗΓΙΑ για την εναρμόνιση των νομοθεσιών των κρατών μελών σχετικά με τη διαθεσιμότητα στην αγορά ηλεκτρολογικού υλικού που προορίζεται να χρησιμοποιηθεί εντός ορισμένων ορίων τάσης | L96/357-L96/374 29.03.2014   |
| Εναρμονισμένα πρότυπα: | EN 60598-1:2015<br>EN 60598-2-1:1989<br>EN 62493:2010<br>EN 62471:2008   | Φωτιστικά σώματα - Μέρος 1: Γενικές απαιτήσεις και δοκιμές<br>Φωτιστικά σώματα - Μέρος 2-1: Ειδικές απαιτήσεις - Σταθερά φωτιστικά σώματα γενικής χρήσης<br>Αξιολόγηση του εξοπλισμού φωτισμού όσον αφορά την έκθεση ατόμων σε ηλεκτρομαγνητικά πεδία<br>Φωτοβιολογική ασφάλεια λαμπτήρων και συστημάτων λαμπτήρων |

Δηλώνεται η συμμόρφωση με άλλες οδηγίες/κανονισμούς που ισχύουν επίσης για το προϊόν:

|                       |  |   |
|-----------------------|--|---|
| <b>2014/30/EU</b>     | Richtlinie zur Harmonisierung der Rechtsvorschriften der Mitgliedstaaten über die elektromagnetische Verträglichkeit | L 96/79- L 96/106 29.3.2014                   |
| Harmonisierte Normen: | EN 55015 :2013   | Όρια και μέθοδοι μέτρησης των χαρακτηριστικών |

## ΔΗΛΩΣΗ ΣΥΜΜΟΡΦΩΣΗΣ ΕΕ

Σύμφωνα με ΟΔΗΓΙΑ 2014/35/ΕΕ ΤΟΥ ΕΥΡΩΠΑΪΚΟΥ ΚΟΙΝΟΒΟΥΛΙΟΥ ΚΑΙ ΤΟΥ ΣΥΜΒΟΥΛΙΟΥ Επίσημη Εφημερίδα L96/357-L96/374  
29.03.2014

|                     |   |  |
|---------------------|---|--|
|                     | <p>EN 61000-3-2:2014</p> <p>EN 61000-3-3:2013</p> <p>EN 61547:2009</p>  | <p>ραδιοδιαταραχών του ηλεκτρικού φωτισμού και παρόμοιων συσκευών</p> <p>Ηλεκτρομαγνητική συμβατότητα (ΗΜΣ) - Μέρος 3-2: Όρια - Όρια για εκπομπές αρμονικού ρεύματος</p> <p>Ηλεκτρομαγνητική συμβατότητα (ΗΜΣ) - Μέρος 3-3: Όρια - Περιορισμός των μεταβολών της τάσης, των διακυμάνσεων της τάσης και του τρεμοπαίγματος σε δημόσια συστήματα διανομής χαμηλής τάσης για εξοπλισμό με ονομαστικό ρεύμα <math>\leq 16</math> A ανά φάση που δεν υπόκειται σε ειδικές συνθήκες σύνδεσης</p> <p>Εξοπλισμός για σκοπούς γενικού φωτισμού - Απαιτήσεις ανοσίας ΗΜΣ</p> |
| <b>2011/65/ΕΕ</b>   | <p>ΟΔΗΓΙΑ για τον περιορισμό της χρήσης ορισμένων επικίνδυνων ουσιών σε ηλεκτρικό και ηλεκτρονικό εξοπλισμό</p> <p>Εναρμονισμένα πρότυπα:</p> <p>EN 50581:2012</p> <p>EN IEC 63000:2018</p>       | <p>L 174/88-L 174/110 01.07.2011</p> <p>Τεχνική τεκμηρίωση για την αξιολόγηση του ηλεκτρικού και ηλεκτρονικού εξοπλισμού όσον αφορά τον περιορισμό των επικίνδυνων ουσιών</p> <p>Τεχνική τεκμηρίωση για την αξιολόγηση του ηλεκτρικού και ηλεκτρονικού εξοπλισμού όσον αφορά τον περιορισμό των επικίνδυνων ουσιών</p>   |
| <b>2009/125/ΕΚ</b>  | <p>ΟΔΗΓΙΑ για τη θέσπιση πλαισίου για τον καθορισμό απαιτήσεων οικολογικού σχεδιασμού όσον αφορά τα συνδεδεμένα με την ενέργεια προϊόντα</p>  | <p>L 285/10-L 285/35 31.10.2009</p>  |
| <b>2019/2020 ΕΕ</b> | <p>ΚΑΝΟΝΙΣΜΟΣ για τον καθορισμό απαιτήσεων οικολογικού σχεδιασμού των φωτεινών πηγών και των χωριστών διατάξεων χειρισμού των φωτεινών πηγών σύμφωνα με την οδηγία 2009/125/ΕΚ του Ευρωπαϊκού</p> | <p>L 315/209- L 315/240 05.12.2019</p>   |



## ΔΗΛΩΣΗ ΣΥΜΜΟΡΦΩΣΗΣ ΕΕ

Σύμφωνα με ΟΔΗΓΙΑ 2014/35/ΕΕ ΤΟΥ ΕΥΡΩΠΑΪΚΟΥ ΚΟΙΝΟΒΟΥΛΙΟΥ ΚΑΙ ΤΟΥ ΣΥΜΒΟΥΛΙΟΥ Επίσημη Εφημερίδα L96/357-L96/374  
29.03.2014

|                     |   |                               |
|---------------------|---|-------------------------------|
|                     | Κοινοβουλίου και του Συμβουλίου και για την κατάργηση των κανονισμών (ΕΚ) αριθ. 244/2009, (ΕΚ) αριθ. 245/2009 και (ΕΕ) αριθ. 1194/2012 της Επιτροπής  |                               |
| <b>2017/1369/EU</b> | ΚΑΝΟΝΙΣΜΟΙ ΤΟΥ ΕΥΡΩΠΑΪΚΟΥ ΚΟΙΝΟΒΟΥΛΙΟΥ ΚΑΙ ΤΟΥ ΣΥΜΒΟΥΛΙΟΥ   | L 198/1-L 198/23 28.7.2017    |
| <b>2019/2015/EU</b> | ΚΑΤ' ΕΞΟΥΣΙΟΔΟΤΗΣΗ ΚΑΝΟΝΙΣΜΟΣ (ΕΕ) για τη συμπλήρωση του κανονισμού (ΕΕ) 2017/1369 του Ευρωπαϊκού Κοινοβουλίου και του Συμβουλίου όσον αφορά την ενεργειακή επισήμανση των φωτεινών πηγών και για την κατάργηση του κατ' εξουσιοδότηση κανονισμού (ΕΕ) αριθ. 874/2012 της Επιτροπής | L 315/68- L 315/101 5.12.2019 |

Υπογραφή για λογαριασμό και εξ  
ονόματος: **Jokey Sohland GmbH**  
Sohland, 12.07.2021

(τόπος και ημερομηνία )

Markus Blumenschein, Διευθύνων

Σύμβουλος

(όνομα, θέση) (υπογραφή)

# HOFER



20 February 2026

| Photo  | Description  | Ref. Nr.       | Size        | Bar code      |
|--|--|----------------|-------------|---------------|
|    | <b>Mirror 4mm Led mirror</b><br>Lumens 850<br>Black aluminum frame<br>IP44<br><b>Vertical instalation</b>                      | NYT-LED-4HBA   | 60x80cmx5mm | 5291840021774 |
|    | <b>Led mirror 60x80cm</b><br>Magnifying mirror<br>Lumens 1000<br><b>IP44</b><br><b>Horizontal or Vertical instalation</b>      | NYT-LED-MAGR   | 60x80cmx5mm | 5291840023143 |
|    | <b>Led mirror 60x60cm</b><br>With magnifying mirror<br>Lumens 1000<br><b>IP44</b><br><b>Horizontal or Vertical Instalation</b> | NYT-LED-MAGS   | 60x60cmx5mm | 5291840023150 |
|  | <b>Reflecta 1 Led mirror</b><br>Lumens 1000<br><b>IP44</b><br><b>Horizontal or Vertical instalation</b>                        | NYT-LED-60S    | 60x60cmx5mm | 5291840023976 |
|  | <b>Reflecta 2 Led mirror</b><br>Lumens 1000<br><b>IP44</b><br><b>Horizontal or Vertical instalation</b>                        | NYT-LED-60X80R | 80x60cmx5mm | 5291840023983 |
|  | <b>Reflecta 3 Led mirror</b><br>Lumens 1000<br>IP44<br><b>Horizontal or Vertical instalation</b>                               | NYT-LED-50X70R | 50x70cmx5mm | 5291840023990 |
|  | <b>Mirror 4mm LED mirror</b><br>Lumens 850<br><b>IP44</b><br><b>Horizontal or Vertical instalation</b>                         | NYT-LED-5VBA   | 60x80cmx5mm | 5291840021781 |

| Photo  | Description  | Ref. Nr.           | Size     | Bar code      |
|--|--|--------------------|----------|---------------|
|    | <p><b>Stelar 3</b></p> <p>Mirror s/steel frame<br/>semi-silver finish</p> <p>Frame width 2.5cm</p> | NYT-S/SF-SM-40x60  | 40x60cm  | 5291840024331 |
|    | <p><b>Stelar 2</b></p> <p>Mirror s/steel frame<br/>semi-black finish</p> <p>Frame width 2.5cm</p>  | NYT-S/SF-B-40x60   | 40x60cm  | 5291840024324 |
|   | <p><b>Stelar 1</b></p> <p>Mirror s/steel frame<br/>semi-white finish</p> <p>Frame width 2.5cm</p>  | NYT-S/SF-W-40x60   | 40x60cm  | 5291840024317 |
|  | <p><b>Lustar 3</b></p> <p>Mirror s/steel frame<br/>semi-silver finish</p>                          | NYT-S/SF-SM-40x100 | 40x100cm | 5291840024362 |
|  | <p><b>Lustar 2</b></p> <p>Mirror s/steel frame<br/>semi-black finish</p>                           | NYT-S/SF-B-40x100  | 40x100cm | 5291840024355 |
|  | <p><b>Lustar 1</b></p> <p>Mirror s/steel frame<br/>semi-white finish</p>                           | NYT-S/SF-W-40x100  | 40x100cm | 5291840024348 |

| Photo  | Description  | Ref. Nr.              | Size    | Bar code      |
|--|--|-----------------------|---------|---------------|
|    | <b>Mirror aluminum</b><br><b>Frame / black matt</b>  | NYT-F-BMAT<br>60x60cm | 60x60cm | 5291840022092 |
|    | <b>Mirror aluminum</b><br><b>Frame / black matt</b>  | NYT-F-BMAT<br>65X45cm | 65x45cm | 5291840022085 |
|   | <b>Mirror aluminum</b><br><b>Frame / chrome matt</b> | NYT-F-CMAT<br>60x60cm | 60x60cm | 5291840022115 |
|  | <b>Mirror aluminum</b><br><b>Frame / Chrome matt</b> | NYT-F-CMAT<br>60X45cm | 60x45cm | 5291840022054 |
|  | <b>Mirror aluminum</b><br><b>Frame / Chrome matt</b> | NYT-F-CMAT<br>60x80cm | 60x80cm | 5291840022108 |

| Photo  | Description                                      | Ref. Nr.            | Size          | Bar code      |
|--|--|---------------------|---------------|---------------|
|    | <b>Titan Ogival mirror</b>                       | NYT-BL-50           | 50cmx65cmx5mm | 5291840013762 |
|  | Bijoute  | NYT-BL-55           | 55cmx40cmx5mm | 5291840013854 |
|    | <b>Titan Rectangular mirror</b>                  | NYT-RECT-50         | 50cmx40cmx5mm | 5291840013830 |
|  | Bijoute  | NYT-RECT-60         | 60cmx45cmx5mm | 5291840013779 |
|  | Can be placed vertical and horizontal            | NYT-RECT-80         | 80cmx60cmx5mm | 5291840019528 |
|    | <b>Titan Square mirror</b>                       | NYT-SQ-40           | 40cmx40cmx5mm | 5291840013847 |
|  | Bijoute  | NYT-SQ-50           | 50cmx50cmx5mm | 5291840013809 |
|  |  | NYT-SQ-60           | 60cmx60cmx5mm | 5291840022399 |
|   | <b>Titan Round mirror</b>                        | NYT-RN-40           | 40cmx5mm      | 5291840013816 |
|  | Bijoute  | NYT-RN-50           | 50cmx5mm      | 5291840013793 |
|  |  | NYT-RN-60           | 60cmx5mm      | 5291840013786 |
|  | <b>Titan Oval mirror</b>                         | NYT-OV              | 50cmx4cmx5mm  | 5291840013823 |
|  | Bijoute  |                     |               |               |
|  | <b>Curve mirror</b><br>Rectangular 60x45cmx5mm   | NYT-CURVE-<br>60x45 | 45cmx60cmx5mm | 5291840021552 |
|  | Bijoute  |                     |               |               |
|  | <b>Curve mirror 4mm</b><br>Rectangular 60x80cm   | NYT-CURVE-<br>80x60 | 60cmx80cmx5mm | 5291840021576 |
|  | Bijoute  |                     |               |               |
|  | <b>Curve mirror 4mm</b><br>Square mirror 60x60cm | NYT-CURVE-<br>60x60 | 60cmx60cmx5mm | 5291840021569 |
|  | Bijoute  |                     |               |               |
|  | <b>Mirror Caresse</b><br>R900-1-K. OAK           | R900-1-K.           | 85cmx55cm     | 5291840018668 |
|  | R900-1-WH White                                  | <i>Lumiere</i>      |               |               |

**TATAY**

Designed to last



20 February 2026



**Magnifying standing mirror 17cm**  
X 5 zoom  
chrome

Ref.Nr. 4440100

Bar code 8411801440100



**Magnifying mirror with bracket 17cm**  
X 5 zoom  
chrome

Ref.Nr. 4440200

Bar code 8411801440209



**Magnifying extending mirror 17cm**  
X 5 zoom  
chrome

Ref.Nr. 4440300

Bar code 8411801440308

mirrors