

■ SILFRA

BATHROOM TECH



Date: 29 December 2022

Q4252 Chrome

Automatic tap for washbasin with temperature regulator

The new Quik 4 series of automatic taps has been designed and created with a new cartridge which allows for simple control of timing and flow rate. It is possible to progressively vary the timing and flow rate without removing the cartridge from the tap will always be perfectly regulated.

Furthermore, any impurities in the water are removed directly by an internal filter. Regulating Flow rate (A):

1. remove the cover from the tap (a1);
2. Press the cartridge button (a2);
3. Rotate with the screwdriver until the required flow rate is obtained (a3).

Regulating Timing (B):

1. remove the cover from the tap (b1);
2. Rotate clockwise with the screwdriver to reduce the flow time, anti-clockwise to increase it (2b).

To adjust the flow rate and timing for in-wall taps Q4 110- Q4 150- Q4 152- Q4 530, take out the plate which will automatically take the tap cover with it. Then proceed as normal with the regulation of flow rate and timing as shown in the following illustrations.

The cartridge can be unscrewed using

A special key made of thermoplastic material in order to replace it or take it apart to remove any impurities which have built up in the socket filter (fig C).

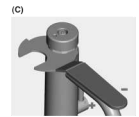
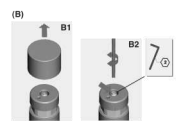
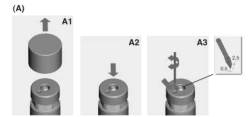
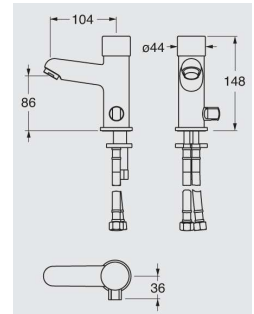

AT977

(15 sec)-Regulation: 3-35 sec.

Cartridge for washbasin model Q4 250-Q4 252

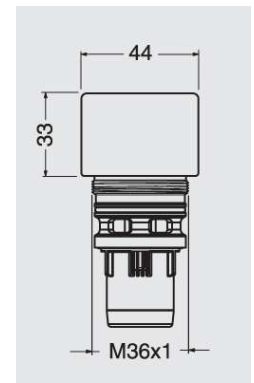

Θα πρέπει να χρησιμοποιείτε πιεστικό στην εγκατάσταση των βαλβίδων των σειρών Quick2 & Quik

Οι αποδόσεις που αναφέρονται στους πίνακες και στον τιμοκατάλογο είναι με πίεση 3 Bar.

The ranges QUIK 2 and QUIK have the following characteristics: Adjustable flow rate (patented system), the time can be regulated (patented system), incorporated filter.

SILFRA supplies cup B for the wash basin model, and cup D for the shower and urinal models.

Changing the cup, it is possible to modify the flow rate. The scheme show the different flow rates depending on the different cups. With a pressure of 3 bars, it is possible to obtain the following values.

The medium time rate, van be reduced using the disc S and T. putting disc S inside the cup, the time will be reduced of 3 seconds; using disc T the time will be reduced of 3 seconds.

Cartridge cup	Flow rate
A	5,0 L/min=0,08L/sec
B	5,8 L/min=0,1L/sec
C	8,0 L/min=0,13L/sec
D	9,5 L/min=0,16L/sec

Model	Time
Wash basin QK 230-235-240 Q2 230-235-240	12" ± 3"
Urinal QK 100-105 Q2 100-105	8" ± 3"
Shower QK 105-165-150 Q2 105-150-165	30" ± 10"

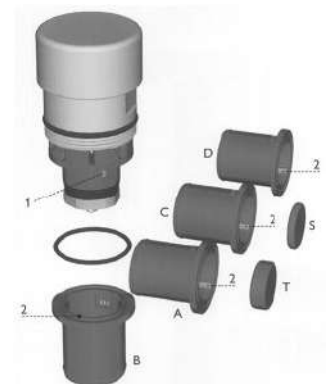

Q5250 Chrome
Automatic tap for wash basin
The range QUIK, QUIK 2 and QUIK have the following characteristics: Adjustable flow rate (patented system), the time can be regulated (patented system), incorporated filter.

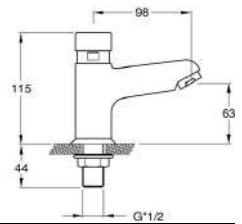

AT93651 chrome (10÷15sec.)
Cartridge for wash basin Q2 230

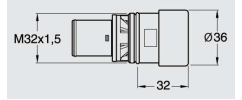

QK23551 10cm
Wall mounted wash-basin automatic tap
Δυνατότητα ρύθμισης ποσότητας ροής νερού. Ρύθμιση χρόνου ροής νερού 10ή 15ή 20 sec..Με ενσωματωμένο φίλτρο νερού.

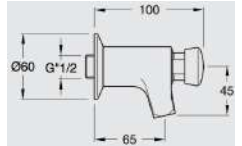

QK24051 16.3 cm
Extended wall mounted wash basin automatic tap
Δυνατότητα ρύθμισης ποσότητας ροής νερού. Ρύθμιση χρόνου ροής νερού 10 ή 15 ή 20 sec..Με ενσωματωμένο φίλτρο νερού.

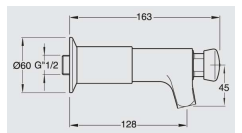

QK15051
Concealed shower automatic tap
Δυνατότητα ρύθμισης ποσότητας ροής νερού. Ρύθμιση χρόνου ροής νερού 20ή 30ή 40 sec..Με ενσωματωμένο φίλτρο νερού.

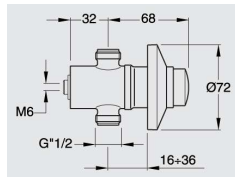

QK16051
1 exit
Wall mounted shower automatic tap
Δυνατότητα ρύθμισης ποσότητας ροής νερού. Ρύθμιση χρόνου ροής νερού 20 ή 30 ή 40 sec..Με ενσωματωμένο φίλτρο νερού.

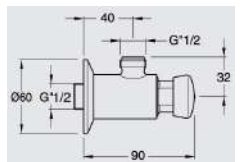

QK16551
2 exit
Wall mounted shower automatic tap
Δυνατότητα ρύθμισης ποσότητας ροής νερού. Ρύθμιση χρόνου ροής νερού 20 ή 30 ή 40 sec..Με ενσωματωμένο φίλτρο νερού.

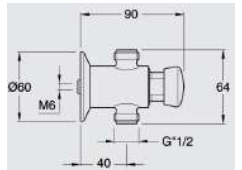

QK10051
1 exit
Wall mounted urinal automatic tap
Δυνατότητα ρύθμισης ποσότητας ροής νερού. Ρύθμιση χρόνου ροής νερού 5 ή 8 ή 11 sec..Με ενσωματωμένο φίλτρο νερού.

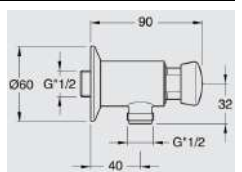

QK10551
2 exit
Wall mounted urinal automatic tap
Δυνατότητα ρύθμισης ποσότητας ροής νερού. Ρύθμιση χρόνου ροής νερού 5 ή 8 ή 11 sec..Με ενσωματωμένο φίλτρο νερού.

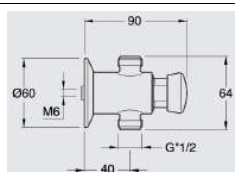

QK11051
Automatic tap for concealed urinal

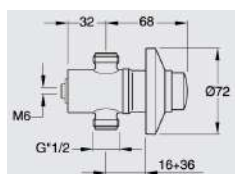

QK810
Wall mounted flush valve with “L” shaped telescopic pipe

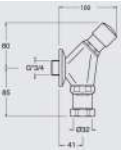

AT05951
“L” shaped telescopic pipe for concealed flush valve
For QK820

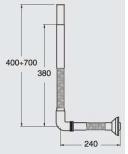

QK82051
QK82051 + AT05951
Concealed flush valve with no-return connection

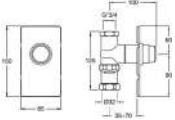

AT90351
Cartridge for concealed flush valve QK82051

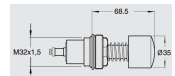

QK920 chrome plated
Concealed flush valve
Εύκολη δυνατότητα ρύθμισης χρόνου & ποσότητας ροής νερού.
Με φίλτρο για προστασία από ακαθαρσίες.

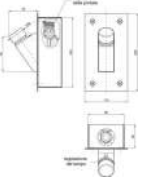

AC07051
No-return connection

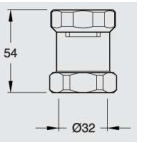

QL23051
Automatic tap for wash basin with elbow-joint lever



QL23551
Wall mounted automatic tap with elbow-joint lever

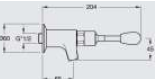

QL10051 1 exit
Wall mounted under basin automatic tap with knee-joint lever

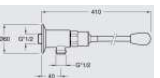

AT91051 (15-20sec)
Cartridge for wash basin automatic tap with elbow-joint lever Q2
230, Q2 235

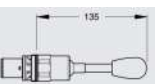

QK40051 on order only
pedal tap for wall or floor installation for water mixing

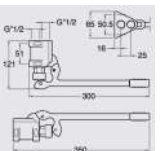

AT96551 on order only
Brass tubular spout for wash basin
aerator /18 connection 1/2”

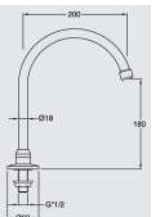

AT96251
Brass tubular spout for wall
aerator Ø26 connection 1/2”

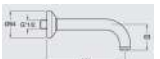

AT90151 (5-11sec.)
Cartridge for urinal QK100, QK103

AT90851 (20-40 sec.)
Cartridge for shower QK160, QK165

AT90651 (10-15 sec.)
Cartridge for wash-basin QK230, QK235, QK240

AT97151 (5-11sec.)
Cartridge for concealed urinal QK110

AT90551 (20-40 sec.)
Cartridge for concealed shower QK150

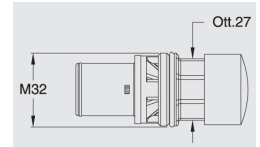
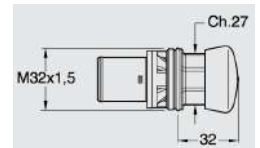

AT95051
Temperature pre-regulator with no return valves for automatic tap

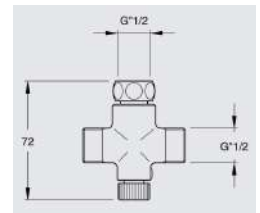

AT92451
Urinal cover

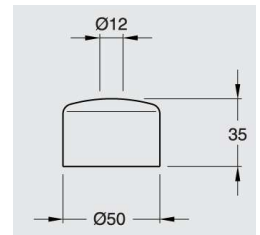

AC92051
Connection 1/2" with telescopic pipe

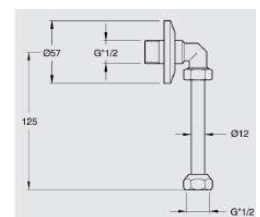

AT870
Wrench for cartridge

